

Installation Instruction For Acrylic Jetted Corner Shower 9002

Aquapat Premium Shower Cabin
Model Number: 9002
Dimension: 36" X 36" X 84"



IMPORTANT

Please read carefully the following instructions before installing your Shower Unit. If you have any questions on this shower installation - please call our technical support specialists Monday to Friday 9:00 am – 5:00 pm Central Time at **1-866-254-2219** **Option 3** or e-mail our technical support group at **sales@masterfaucet.com**

Preparation

1. After opening the case, read this introduction carefully, check all the packed parts are complete by cross checking all the components against the "Diagram of Shower Components". Examine for shipping damage. If the unit has been damaged or has a finishing defect, please contact Master Faucet within 2 business days. Please note that **Master Faucet will not replace any damaged product or parts free of charge, ONCE the product has been installed.** Master Faucet responsibility for damage in transit is limited after the shower package has been transferred to the transportation company, so you may have to contact the transportation company directly to report damage. Contact Master Faucet if you have any questions.
2. You should also consult your local building codes on questions on installation compliance standards.
3. Install all of the required plumbing and drainage before securing the shower base. **Use a competent and licensed (if required by local code) plumber for all plumbing installation.**

Tools Required

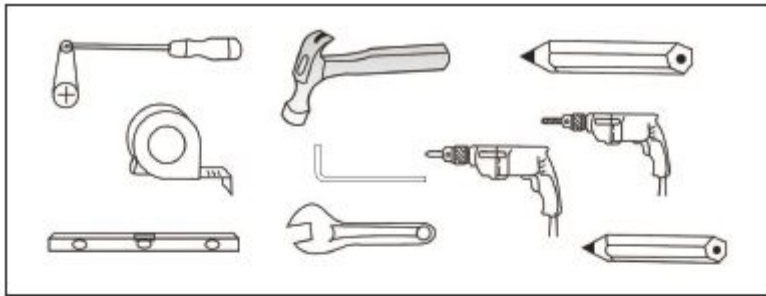

1. Philips screwdriver
2. Hammer
3. Pencil
4. Tape measure
5. Allen key
6. Drill
7. Level
8. Adjustable wrench

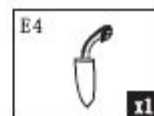
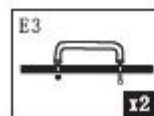
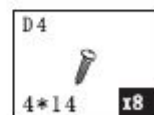
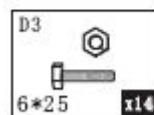
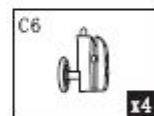
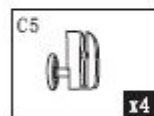
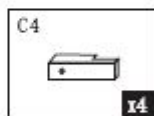
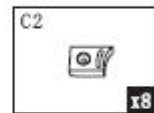

Drawing of adjusting the shower base.

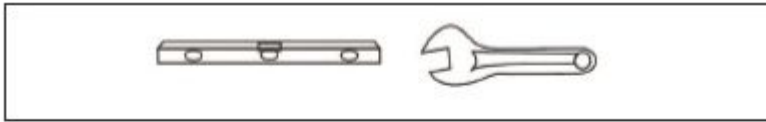

Open all of the boxes and inspect the product. Take out the base and attach the drain to it, then lay the base in its place and level it out adjusting the feet.

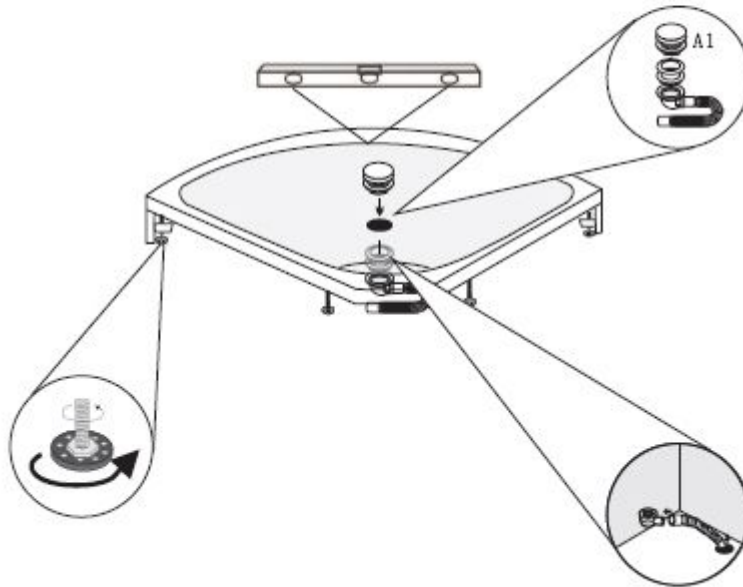

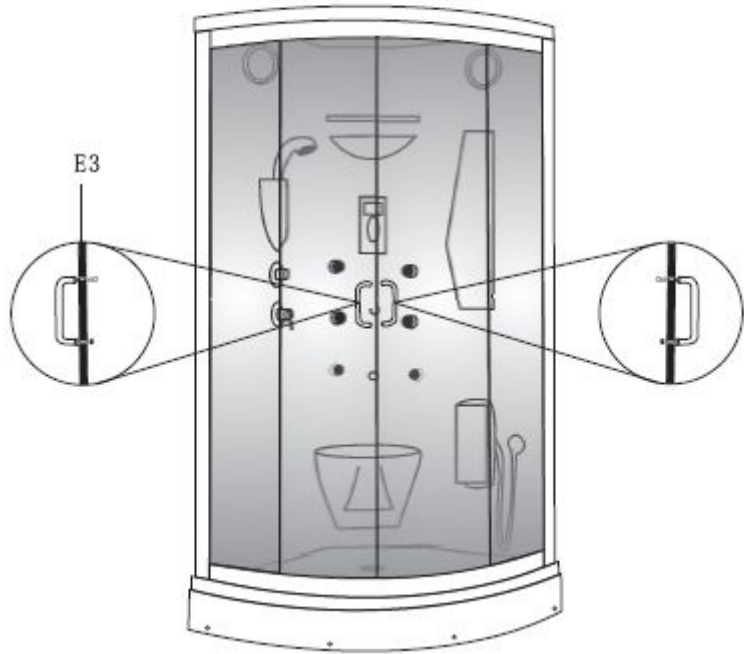
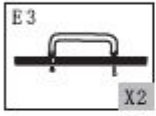
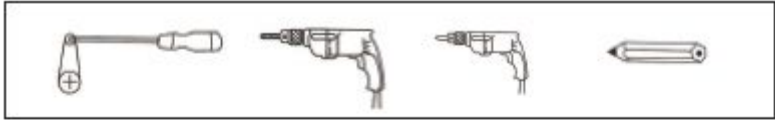

Drawing of assembling the back.

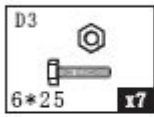
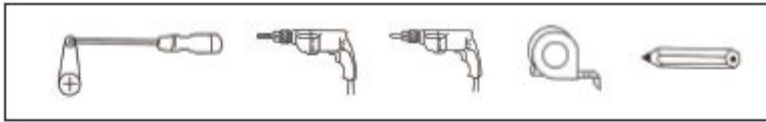

Now remove the base from its place to the middle of your bathroom so you have room to move around it. Take out the back piece from the packing and rest it on the base. Grab the bolts and nuts insert them trough the back piece in to the base ant tighten them. Do the same with the top cover.

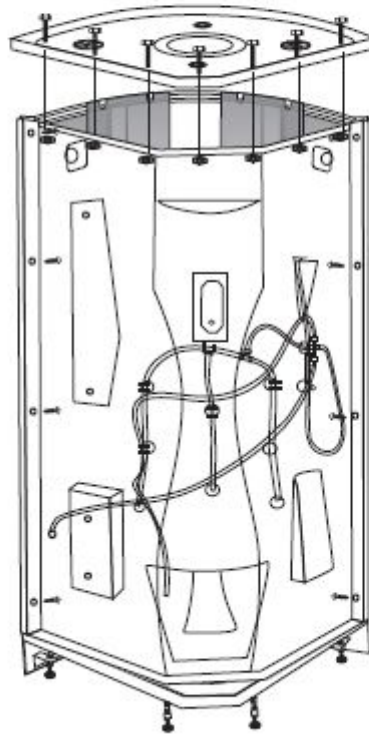

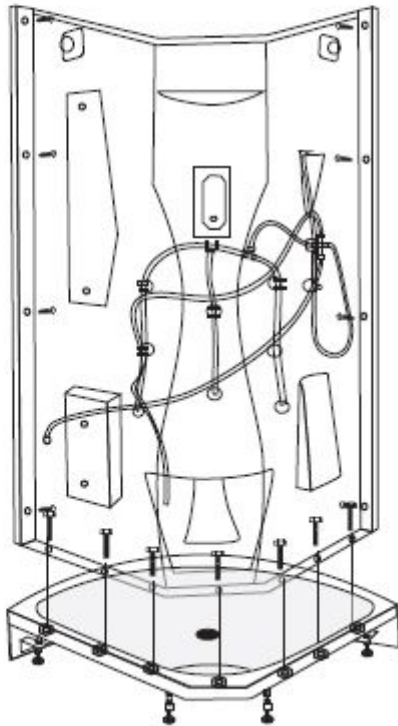
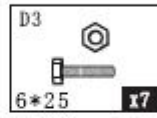
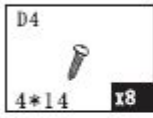
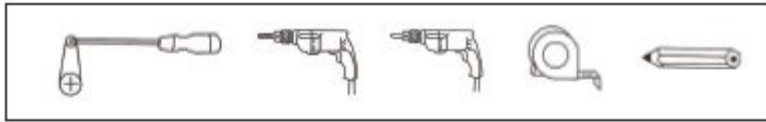

Drawing of components installations.

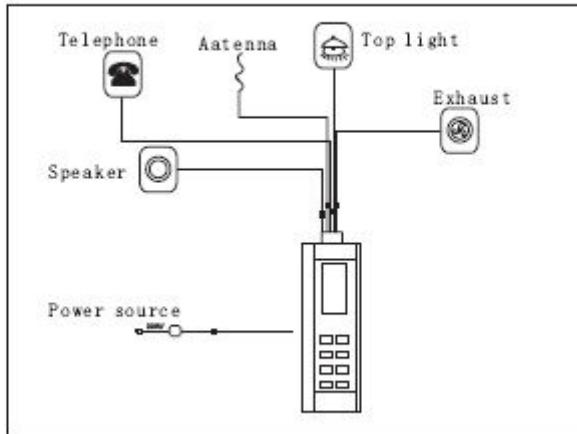

Now we have the back piece and the top cover tighten together we can start on the front. Remove the 2 aluminum frames and 2 aluminum rails and attach them with B1 screws like you see it on the image. Since the aluminum frames are mounted to the rail you can insert the small pieces of glass make sure the rubber seals are in place then push the glass in to the frames. Now insert the front frames with the glass in to the cabin, Drill holes trough the back piece in to the frame and tighten it with the screws.

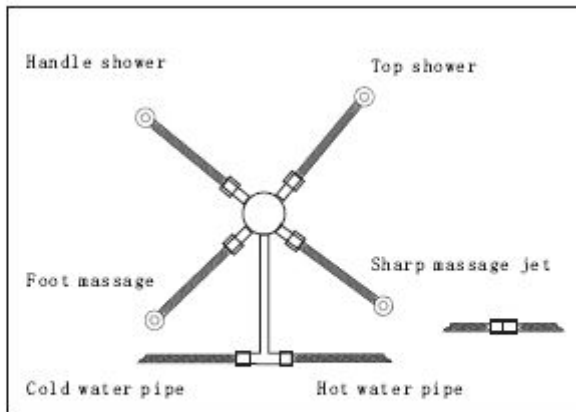

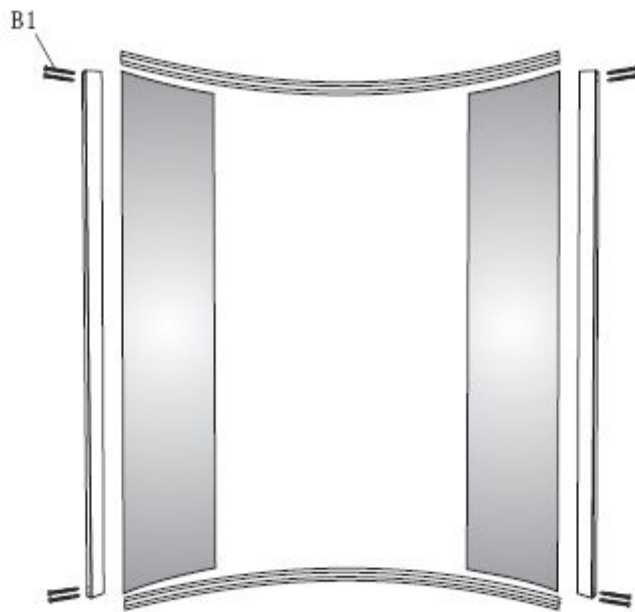
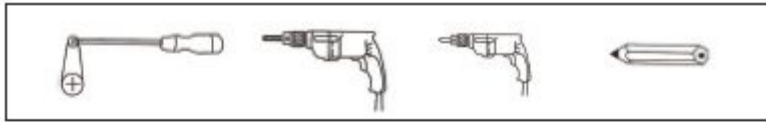

Drawing of assembling the body and glass doors.

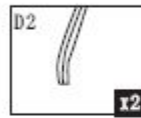
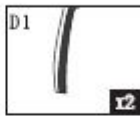
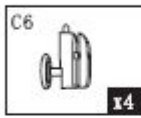
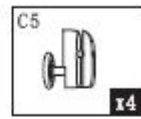
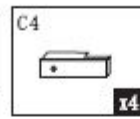
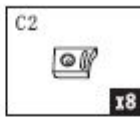
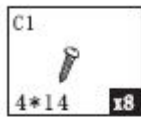

Find C5 and C6 rollers insert them in to the rails and then insert the glass in to the rollers and tighten them. Cabin is now assembled so you can install the hand held shower and foot massage. This is a final step climb up on the latter and connect the shower head hose to the shower head. Now you can move the cabin back to its place and connect the water supply lines to your valves .

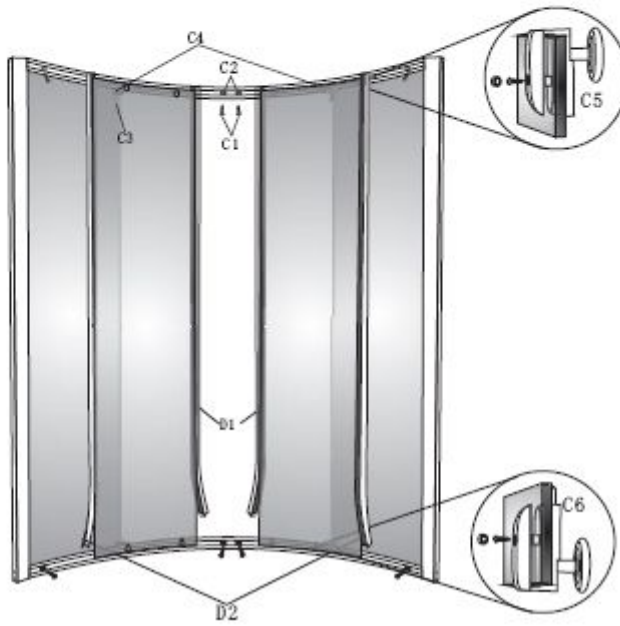

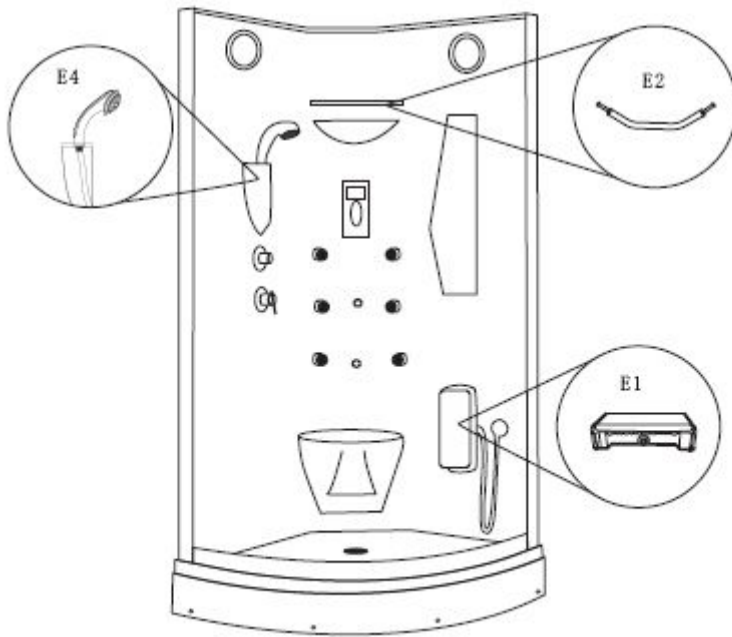
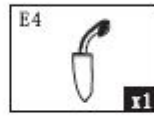
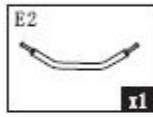
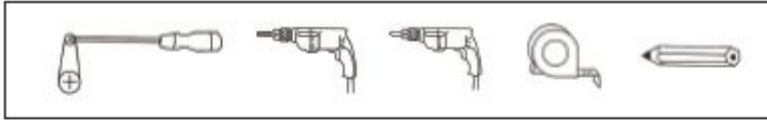

Drain installations - Optional steam unit installation.
(Steam Generator Not Included)

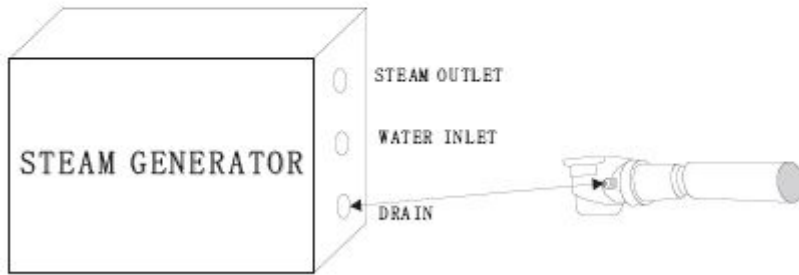



Product Maintenance

Tempered glass doors and acrylic walls can be clean with nonabrasive bathroom cleaner or any glass cleaner you use elsewhere in your home.

Our product may have changes without prior notice 6

For additional information contact AquaPat Showers at 877 789 AQUA (2782) or visit our website at www.aquapat.com or www.masterfaucet.com